

Helo-Wood burning heaters



Sauna with Finnish soul

The sauna manufacturing traditions of Saunatec Group Ltd stretch as far back as the year 1919. Today, Helo's strict quality requirements, smart innovations and desire to produce cutting-edge sauna products and adopt the sauna cultures of different countries have made Helo the world's leading and best known brand countries of sauna heater. The Helo brand is steeped in Finnish sauna expertise, workmanship and the rich history and traditions of Finnish sauna.

The inspiring new design, materials and technology of the latest Helo wood burning sauna heater range work together to further boost your sauna enjoyment. The new design opens up opportunities for a unique new style of sauna furnishing. Create your sauna in a whole new way with the new heater range from Helo - a brand you can always depend on.



Ukkotonttu



The floor is recommended to be protected by an adjustable base plate.



Adjustment measure ca 40mm



The chrome steel connecting tube has an 180 degree adjustment angle.

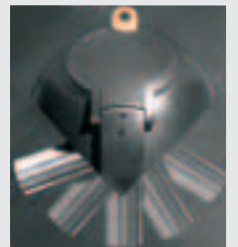

The unique 3 level flame circulation system.

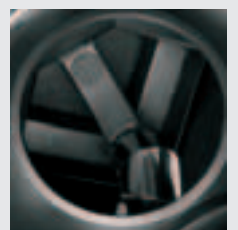

Ukkotonttu wood-burning sauna heater: Original Finnish sauna tradition with modern design by Ristomatti Ratia. Cast iron door with glass window is standard. Adjustable base plate is an option. For saunas 8-22 m³.

Hiidenkivi



The inner body of the heater is changeable.

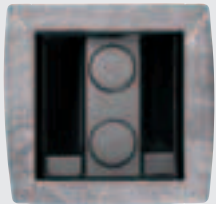

Soapstone for stylish looks.



The grate made of cast iron, changeable.

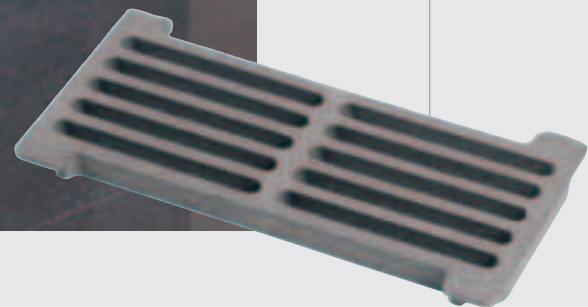

Beautiful wood-burning sauna heater made of soapstone. Exclusive design and excellent properties due to the heat restoring stone cover. The cast iron door with window allows you to enjoy the play of the flames!

For saunas 8-18 m³.

Helo 22 DX
Helo 28 DX

Helo 22 DX RST
Helo 28 DX RST



Helo 22 DX, the superb new design and quality material selection of this model lends a pleasing new feel to your sauna experience. The heater's fuel-efficient twin flame circulation system guarantees extremely low wood consumption. The solid cast iron fire door is a standard feature. Adjustable feet are also available as an option. Helo 22 DX, for saunas 8-22 m³.

Optional adjustable feet, 40 mm.

Helo 28 DX rst, attractively coloured brushed stainless steel lends brightness and space to your sauna. Adjustable feet make precise mounting of the heater easy. Helo 28 DX, for saunas 12-28 m³.

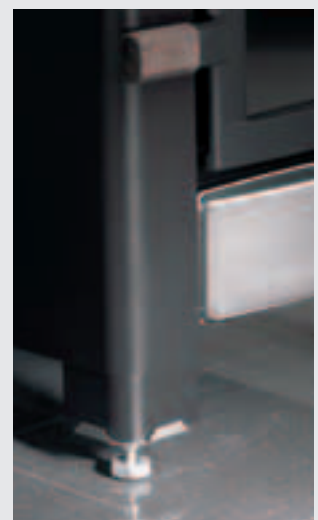

Helo 22 ES DX RST
Helo 28 ES DX RST

Helo 22 ES DX
Helo 28 ES DX



Helo Pata DX, water heater

A wood-burning water heater, with water volume up to 60 l. The design complements the attractive DX range. The Pata water heater can be connected to the flue from above or behind. The water tap can be installed either on the right or left-hand side. Cast iron door with glass window is standard.



Helo 22 ES DX, Helo 28 ES DX, Helo 22 ES DX rst and Helo 28 ES DX rst
A practical and space-saving new-look sauna heater fitted with handy front water tank. The water tap can be conveniently installed either on the right or left-hand side. Adjust the water heating speed by simply turning an intergal lever! Choose from either stainless steel/black or stainless steel colour, complete with cast iron fire door with glass window. Fuel-efficient dual flame circulation system.

Helo 16 S
Helo 20 S

Helo 18 ES



New Helo Black Line standard models. The heater structure incorporates a heavy-duty 8 mm thick (minimum) firebox cover. Helo 16 S for saunas 6-16 m³.

Helo 20 S sauna heaters are equipped with twin flame circulation system and large rock capacity. For saunas 8-22 m³. Adjustable feet are optional.

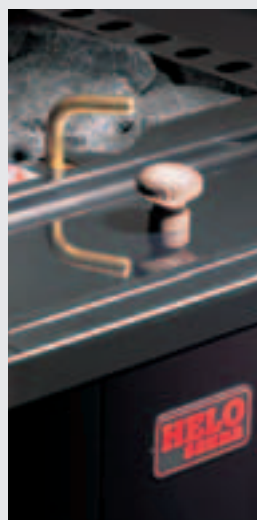

Helo 18 ES, space-saving front water tank. The tap can be installed on either the left or right-hand side. The water heating speed can be adjusted to your liking. Heavy-duty 8 mm thick firebox cover. X-TRA flame circulation system.

Helo 16 L

For saunas 6-16 m³. An efficient model with a large rock capacity. Door with glass window is standard.



Helo 40

The sauna heater for big saunas. Suitable for saunas of 20-45 m³. The heater's 100 kg rock capacity guarantees even heat and good smooth steam.



Helo 18 SL

Specially designed to fill the oven from outside the sauna room, for example from dressing room. Handsome cast iron foot with glass window is standard! This is a brand new convenient design from Helo. For saunas of 8-18 m³.



First class accessories of chrome steel



Connecting tube 60 °



Connecting tube 90 °



Chimney mounted water tank 24 l.



Conical tube



Connection sleeve



Extension tubes
330-1000 mm



Tube collar
ø 115 mm



Adjustable feet



Connection sleeve for brickwork

Helo chimney flue

STF 18/6/221/2000

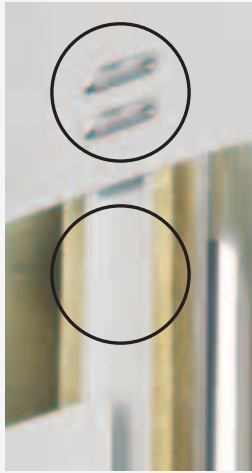

The unique STF, approved Helo chimney flue has a patented flow-through cooling system which prevents the flue from sweating and thus prolongs its life-time.

The Helo chimney flue is light and durable. It is easy to install and does not require any special construction. Included with the chimney is a complete installation kit.

The chimney flue's use is permitted for fixed fuels, (e.g. wood), maximum power for fireplace 25 kW.

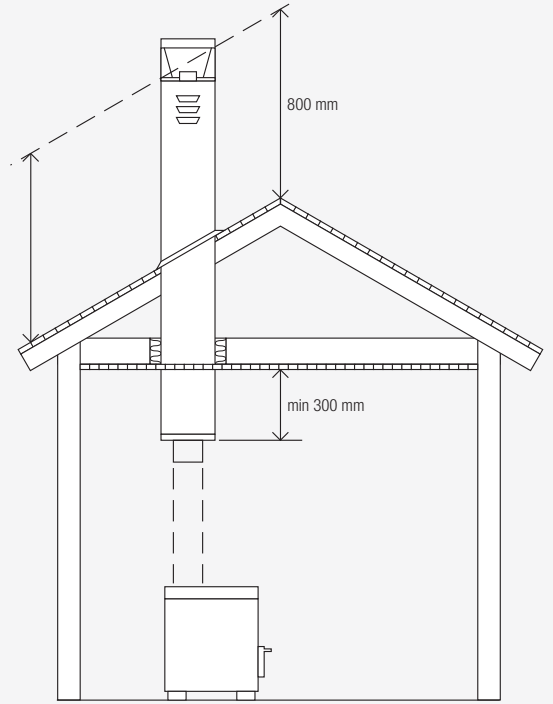

Damper tube, side



Damper tube, above

CONNECTION SLEEVE

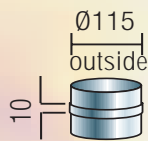

DAMPER TUBE

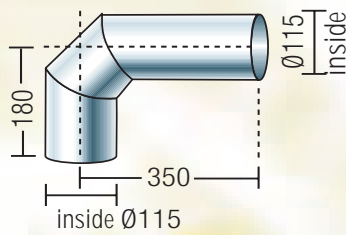
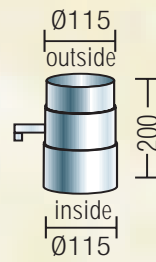

CONNECTING TUBE 90°

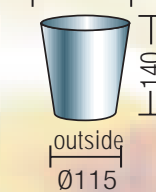

CONICAL TUBE

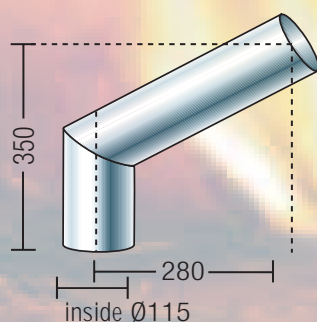

CONNECTING TUBE 60°

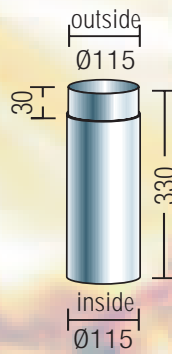

EXTENSION TUBE

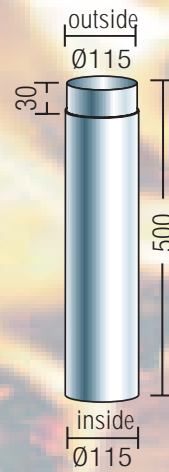

EXTENSION TUBE

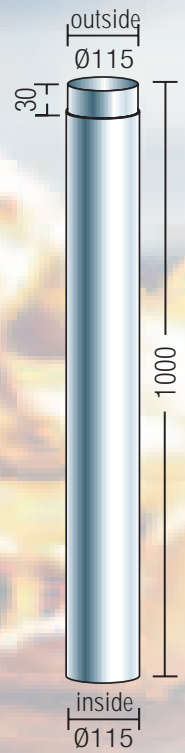

EXTENSION TUBE

Original Finnish sauna culture since 1919

This new, unique range of wood burning heaters has been created by our Helo sauna experts with a particular aim in mind - to lend a satisfying new feel to your sauna. Light is one of the key aesthetic elements that we have emphasised in the new design.

Over 60 time-honoured years of wood burning craftsmanship and uncompromising quality requirements have made Helo the world's leading wood burning heater supplier and one which you, the sauna connoisseur, can always depend on.



1919 • 2004

Saunatec

Enjoy your life

